

**Liquid Tight Conduit Connector With Internal Threads,  
Female Liquid Tight Conduit Fittings ( YCM )**

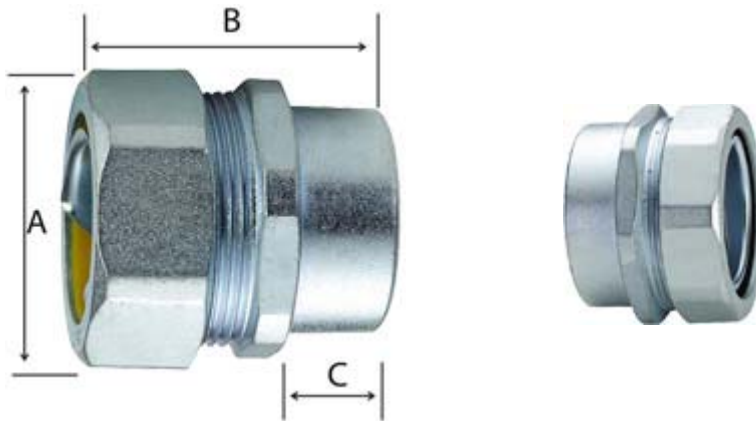

No.	Trade Size	Dimensions (mm)				Threads
		I.D.	A	B	C	
<b>YCM-03</b>	<b>3/8"</b>	11.2	28.3	44.6	13.2	PT 1/2"
<b>YCM-04</b>	<b>1/2"</b>	14.8	34.2	44.6	13.2	PT 1/2"
<b>YCM-06</b>	<b>3/4"</b>	18.7	41.1	51.0	14.3	PT 3/4"
<b>YCM-10</b>	<b>1"</b>	24.8	48.6	58.1	19.2	PT 1"
<b>YCM-12</b>	<b>1-1/4"</b>	33.1	56.6	70.2	20.8	PT 1-1/4"
<b>YCM-14</b>	<b>1-1/2"</b>	38.0	71.3	75.7	21.7	PT 1-1/2"
<b>YCM-20</b>	<b>2"</b>	48.8	86.6	84.4	21.7	PT 2"
<b>YCM-24</b>	<b>2-1/2"</b>	59.4	103.1	101.8	25.9	PT 2-1/2"
<b>YCM-30</b>	<b>3"</b>	75.8	120.0	110.0	26.4	PT 3"
<b>YCM-40</b>	<b>4"</b>	97.6	157.0	118.6	29.0	PT 4"
<b>YCM-50</b>	<b>5"</b>	139.0	168.0	96.0	29.0	PT 5"
<b>YCM-60</b>	<b>6"</b>	143.0	194.9	109.9	31.3	PT 6"

*Female liquid tight connector connects the flexible conduit to male threads.*

Available with Internal Threads : **PT, G, PF, PG, METRIC, NPT**



**Typical applications** for liquid tight connector with internal threads: Coupling a flexible conduit to IMC or RSC conduit

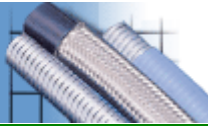

## Aluminum Liquid Tight Connector Fixed and Swivel Liquid Tight Conduit Fittings

*High quality and durability are synonymous with the Delikon family of products, and the DELIKON YA line of Aluminum Liquid Tight connectors is no exception. Benefits of Delikon Liquid Tight Connector:*

- Superior environmental seal
- Installation time savings
- Reduce maintenance downtime
- Secured connections in harsh industrial environments

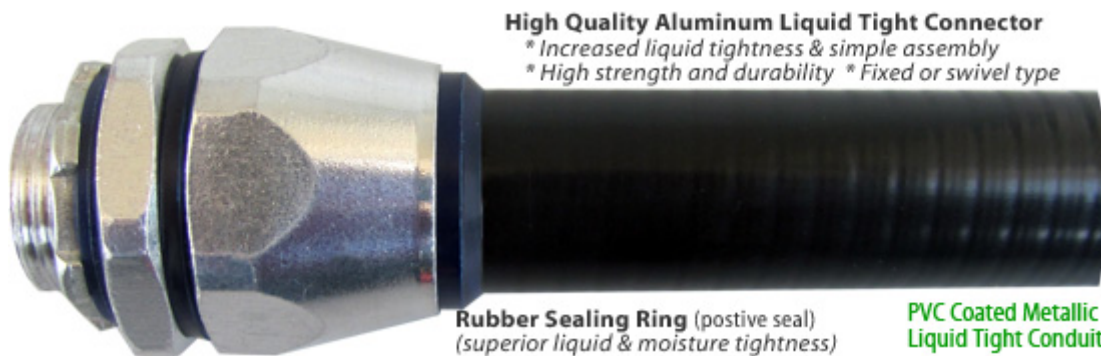

Rubber Cone Gasket with Sealing Nut Interior Cone Shape design for this line of liquid tight connector provides increased liquid tightness when the nut is tightened, positively keeping liquid and moisture out in demanding industry environments.



**Delikon Aluminum Liquid Tight Connector**

**Anodized Finishes Color Samples**



This line of aluminum liquid tight connectors are produced by (1) **Machining** of extruded aluminum rod, with polishing or anodized finish or by (2) **Aluminum die casting** with metal plating, painting or powder coating finishes

(1) By machining of extruded aluminum rod

(2) Or by aluminum die casting process



Polishing or Anodized finish



Metal Plating, Painting or Powder Coating finish

**Fixed Type: YAB**

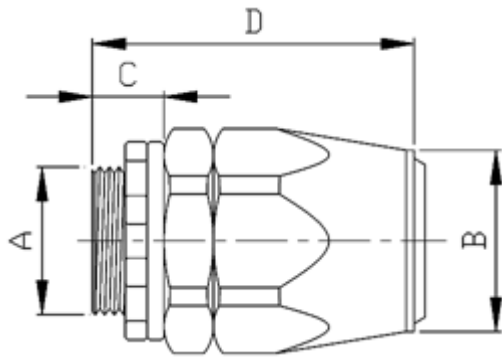

This liquid tight fitting can be inserted into a knockout and secured with a locknut. Or it could be installed in a threaded hole. Most suitable for connecting flexible conduits to electrical boxes or enclosures.



Catalog No.	Nominal Size	Connector Dimension (mm)					Threads
		I. D.	A	B	C	D	
YAB-03B	3/8"	10.5	20.3	24.0	11.0	41.0	G 1/2"
YAB-04B	1/2"	14.0	20.3	27.0	11.0	47.0	G 1/2"
YAB-06B	3/4"	17.7	25.7	34.0	13.0	54.0	G 3/4"
YAB-10B	1"	24.0	32.0	42.0	14.0	61.0	G 1"
YAB-12B	1-1/4"	33.0	41.0	52.0	16.0	68.0	G 1-1/4"
YAB-14B	1-1/2"	38.0	46.5	59.0	20.0	78.0	G 1-1/2"
YAB-20B	2"	49.0	59.0	71.0	20.0	83.0	G 2"
YAB-24B	2-1/2"	59.4	75.4	103.0	22.0	62.0	G 2-1/2"
YAB-30B	3"	75.8	87.5	120.0	22.0	65.0	G 3"
YAB-40B	4"	97.6	113.0	157.0	24.0	72.0	G 4"



**Fixed Type**

**Swivel Type: YABR**

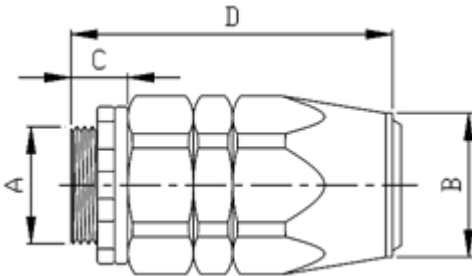

The external thread **swivels** about the main body. It can be used with **threaded entries** or knockout secured with a locknut. Most suitable for installations requiring **motion, vibration** and **bending**.





Catalog No.	Nominal Size	Connector Dimension (mm)					Thread
		I. D.	A	B	C	D	
YABR-03B	3/8"	10.5	20.3	24.0	11.0	56.0	G 1/2"
YABR-04B	1/2"	14.0	20.3	27.0	11.0	62.0	G 1/2"
YABR-06B	3/4"	17.7	25.7	34.0	13.0	69.0	G 3/4"
YABR-10B	1"	24.0	32.0	42.0	14.0	78.0	G 1"
YABR-12B	1-1/4"	33.0	41.0	52.0	16.0	88.0	G 1-1/4"
YABR-14B	1-1/2"	38.0	46.5	59.0	20.0	100.0	G 1-1/2"
YABR-20B	2"	49.0	59.0	71.0	20.0	108.0	G 2"
YABR-24B	2-1/2"	59.4	75.4	103.0	22.0	82.0	G 2-1/2"
YABR-30B	3"	75.8	87.5	120.0	22.0	85.0	G 3"
YABR-40B	4"	97.6	113.0	157.0	24.0	92.0	G 4"



**Swivel Type**

90 Degrees Connector (fixed type)	Model	Size	90 degrees Fixed	Model	Size
	YAL-03B	3/8"		YAL-14B	1-1/2"
	YAL-04B	1/2"		YAL-20B	2"
	YAL-06B	3/4"		YAL-24B	2-1/2"
	YAL-10B	1"		YAL-30B	3"
	YAL-12B	1-1/4"		YAL-40B	4"

90 Degrees Connector (swivel type)	Model	Size	90 degrees Swivel	Model	Size
	YALR-03B	3/8"		YALR-14B	1-1/2"
	YALR-04B	1/2"		YALR-20B	2"
	YALR-06B	3/4"		YALR-24B	2-1/2"
	YALR-10B	1"		YALR-30B	3"
	YALR-12B	1-1/4"		YALR-40B	4"

45 Degrees Connector (fixed type)	Model	Size	45 degrees Fixed	Model	Size
	YAH-03B	3/8"		YAH-14B	1-1/2"
	YAH-04B	1/2"		YAH-20B	2"
	YAH-06B	3/4"		YAH-24B	2-1/2"
	YAH-10B	1"		YAH-30B	3"
	YAH-12B	1-1/4"		YAH-40B	4"

Standard Threads: **G (EXTERNAL)** Pipe thread . With Lock Nut  
 Other Available Threads: **PF**, **PG**, **METRIC**, **NPT**, **INTERNAL THREADS**

Delikon *Swivel* Liquid Tight Conduit Connector is suitable for use with Metal Liquid Tight Conduit or Non Metallic Liquid Tight Conduit (LFMC & LFNC), and coated flexible metal conduit protecting data or power cables of electric motor, blower, pump, polishing grinding machine, or any other applications where there is vibration. Whether the application is power, control, or signal, data, Delikon Swivel Liquid Tight Connector offers *superior environmental seal* and *positive vibration protection* for use with *motor drives* and *moving assemblies*, providing secured and reliable connections for a variety of Industrial OEM Equipment and Factory Floor Automation Systems. Delikon Conduit Fittings excel in applications where flexibility, reliability, and durability are key.



for use with LFMC & LFNC

Swivel Liquid Tight Connector  
 \* Superior environmental seal  
 \* Positive vibration protection

Male or Female Threads : G, PF, PG, METRIC, NPT, PT

**Delikon Swivel Liquid Tight Conduit Connector**  
 for use with Metal Liquid Tight Conduit or Non Metallic Liquid Tight Conduit ( LFMC & LFNC ),  
 protecting data or power cables of electric motor, blower, pump, polishing machine,  
 grinding machine, or any other applications where there is vibration

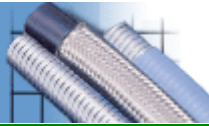

*Corrosion Resistant liquid tight conduit fittings for use with flexible liquid tight metallic conduits, flexible liquid tight non metallic or PVC coated flexible metal conduit.*

*\* Liquidtight, Raintight, OilTight \* Suitable for wet locations and outdoor applications*

*Most suitable for corrosion environments applications*

*Food & beverage*

*Petrochem plants*

*Wastewater treatment*

*Pulp & paper mills*

*Offshore applications*

*Mining Industry*

*Delikon Stainless Steel Liquidtight Connectors offer corrosion resistance and the strength of stainless steel for the highest levels of endurance.*

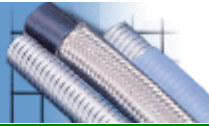

**STRAIGHT STAINLESS STEEL LIQUID TIGHT CONNECTOR ( YSSB )**

Model	Size	ID	0 degree	Model	Size	ID
YSSB-02B	1/4"	8.0		YSSB-20B	2"	48.8
YSSB-03B	3/8"	10.7		YSSB-24B	2-1/2"	59.4
YSSB-04B	1/2"	14.3		YSSB-30B	3"	75.8
YSSB-06B	3/4"	19.3		YSSB-40B	4"	97.6
YSSB-10B	1"	24.4		YSSB-50B	5"	123.0
YSSB-12B	1-1/4"	33.4		YSSB-60B	6"	137.0
YSSB-14B	1-1/2"	38.0				

**90 DEGREES STAINLESS STEEL LIQUID TIGHT CONNECTOR ( YSSL )**

Model	Size	ID	90 degrees	Model	Size	ID
YSSL-02B	1/4"	8.0		YSSL-14B	1-1/2"	38.0
YSSL-03B	3/8"	10.7		YSSL-20B	2"	48.8
YSSL-04B	1/2"	14.3		YSSL-24B	2-1/2"	59.4
YSSL-06B	3/4"	19.3		YSSL-30B	3"	75.8
YSSL-10B	1"	24.4		YSSL-40B	4"	97.6
YSSL-12B	1-1/4"	33.4				

**45 DEGREES STAINLESS STEEL LIQUID TIGHT CONNECTOR ( YSSH )**

Model	Size	ID	45 degrees	Model	Size	ID
YSSH-02B	1/4"	8.0		YSSH-14B	1-1/2"	38.0
YSSH-03B	3/8"	10.7		YSSH-20B	2"	48.8
YSSH-04B	1/2"	14.3		YSSH-24B	2-1/2"	59.4
YSSH-06B	3/4"	19.3		YSSH-30B	3"	75.8
YSSH-10B	1"	24.4		YSSH-40B	4"	97.6
YSSH-12B	1-1/4"	33.4				

Delikon Stainless Steel Liquid Tight connector is available with  
**Male** or **Female** threads: **G, NPT, PG, METRIC**

*Delikon Stainless Steel Liquid Tight Conduit and Stainless Steel Liquid Tight Connector are widely chosen by water treatment plant, sewage treatment plant, petrochemical plant, Oil & Gas industry, mining industry, food & beverage and pharmaceutical industry, paper industry, offshore industry . . . or applications where better corrosion resistance is required.*

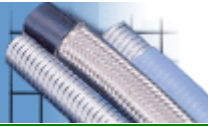

**Conduit Fittings For Over Braided Flexible Conduit, Fittings for heavy series flexible sheath**

( Straight Connector: **YABS**. 90 Degrees Connectors: **YALS**. 45 Degrees Connectors: **YAHS**)

All metal construction, heavy series Conduit Fittings are most suitable for **high temperature** wirings. Or with plastic sealing components for **liquid tight** applications. Metal clamping ring design provides **positive shielding termination**.

Most suitable for over braided flexible conduit and flexible metal conduit. Trade size: 1/4" - 6"  
Available with G, ISO228-1, Metric, PF; NPT or PG threads. **Male** or **Female** Threads



**Straight** Heavy Series Flexible Conduit Fittings

Straight Connector (fixed type)	Model	Size	0 degree Heavy Series Fixed	Model	Size
	YABS-02B	1/4"		YABS-20B	2"
	YABS-03B	3/8"		YABS-24B	2-1/2"
	YABS-04B	1/2"		YABS-30B	3"
	YABS-06B	3/4"		YABS-40B	4"
	YABS-10B	1"		YABS-50B	5"
	YABS-12B	1-1/4"		YABS-60B	6"
	YABS-14B	1-1/2"			

Straight Connector (swivel type)	Model	Size	0 degree Heavy Series Swivel	Model	Size
	YABSR-02B	1/4"		YABSR-14B	1-1/2"
	YABSR-03B	3/8"		YABSR-20B	2"
	YABSR-04B	1/2"		YABSR-24B	2-1/2"
	YABSR-06B	3/4"		YABSR-30B	3"
	YABSR-10B	1"		YABSR-40B	4"
	YABSR-12B	1-1/4"			

The external thread **swivels** about the main body. It can be used with threaded entries or knockout secured with a locknut. Most suitable for installations requiring **motion**, **vibration** and **bending**. Delikon heavy series **Swivel Connector** protects data or power cables of electric motor, blower, pump, polishing machine, grinding machine, or any other applications where there is vibration

### 90 Degrees Heavy Series Conduit Fittings

90 Degrees Connector (fixed type)	Model	Size	90 degrees Heavy Series Fixed	Model	Size
	YALS-03B	3/8"		YALS-14B	1-1/2"
	YALS-04B	1/2"		YALS-20B	2"
	YALS-06B	3/4"		YALS-24B	2-1/2"
	YALS-10B	1"		YALS-30B	3"
	YALS-12B	1-1/4"		YALS-40B	4"

90 Degrees Connector (swivel type)	Model	Size	90 degrees Heavy Series Swivel	Model	Size
	YALSR-03B	3/8"		YALSR-14B	1-1/2"
	YALSR-04B	1/2"		YALSR-20B	2"
	YALSR-06B	3/4"		YALSR-24B	2-1/2"
	YALSR-10B	1"		YALSR-30B	3"
	YALSR-12B	1-1/4"		YALSR-40B	4"

### 45 Degrees Heavy Series Conduit Fittings

45 Degrees Connector (fixed type)	Model	Size	45 degrees Heavy Series Fixed	Model	Size
	YAHS-02B	1/4"		YAHS-14B	1-1/2"
	YAHS-03B	3/8"		YAHS-20B	2"
	YAHS-04B	1/2"		YAHS-24B	2-1/2"
	YAHS-06B	3/4"		YAHS-30B	3"
	YAHS-10B	1"		YAHS-40B	4"
YAHS-12B	1-1/4"				

45 Degrees Connector (swivel type)	Model	Size	45 degrees Heavy Series Swivel	Model	Size
	YAHSR-02B	1/4"		YAHSR-14B	1-1/2"
	YAHSR-03B	3/8"		YAHSR-20B	2"
	YAHSR-04B	1/2"		YAHSR-24B	2-1/2"
	YAHSR-06B	3/4"		YAHSR-30B	3"
	YAHSR-10B	1"		YAHSR-40B	4"
YAHSR-12B	1-1/4"				

Delikon Heavy Series Over Braided Flexible Conduit, Heavy Series Braided Conduit Fittings protect servo, feedback motor cables, PLC cables, control cables, instrumentation cables. Reducing or eliminating electromagnetic interference (EMI) for cables. Delikon heavy series over braided flexible conduit and connector are particularly recommended for protecting supply cables between frequency converters and servo motors.

For the wiring of machines and system controls, Delikon heavy series braided conduit connector provides High Pull-Out Resistance, Robust Performance, Long Life Expectancy, Fastest and Easy installation.



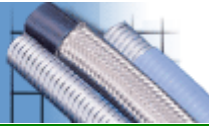

**Delikon Military Circular Connector Backshell, Conduit Adapter, Transitions Fittings ( MAS )**



Delikon Heavy Series Over Braided Flexible Conduit

Delikon Conduit Adapter Backshell

for Shell Size 8 to Shell Size 36

UNEF threaded

Adapter Model	For Conduit Trade Size	For MS Connector Shell Size	MS3057 Part No.	Adapter ID (mm)	Thread in Inches
MAS-0304	3/8"	10SL, 12S	4A	10.7	5/8" - 24 UNEF
MAS-0306	3/8"	14S	6A	10.7	3/4" - 20 UNEF
MAS-0308	3/8"	16S, 16	8A	10.7	7/8" - 20 UNEF
MAS-0310	3/8"	18	10A	10.7	1" - 20 UNEF
MAS-0312	3/8"	20, 22	12A	10.7	1-3/16" - 18 UNEF
MAS-0408	1/2"	16S, 16	8A	14.5	7/8" - 20 UNEF
MAS-0410	1/2"	18	10A	14.5	1" - 20 UNEF
MAS-0412	1/2"	20, 22	12A	14.5	1-3/16" - 18 UNEF
MAS-0416	1/2"	24, 28	16A	14.5	1-7/16" - 18 UNEF
MAS-0612	3/4"	20, 22	12A	19.3	1-3/16" - 18 UNEF
MAS-0616	3/4"	24, 28	16A	19.3	1-7/16" - 18 UNEF
MAS-1016	1"	24, 28	16A	24.4	1-7/16" - 18 UNEF
MAS-1220	1-1/4"	32	20A	33.4	1-3/4" - 18 UNEF
MAS-1424	1-1/2"	36	24A	38.0	2" - 18 UNEF

The need to provide adequate protection to the cables connecting to Military Connector becomes paramount. Delikon backshell design is concerned with the rear end or wire end of the connector.

Delikon Conduit Adapter backshells are designed to attach onto the rear end or wire end of the military connector, connecting Delikon Flexible Conduit to the connector shell rear end geometry. In this way, the cables are fully protected by Delikon EMI Shielding Heavy Series Over Braided Flexible Conduit systems. Delikon MAS Series Conduit Adapter Backshells are offered in complete range of SHELL SIZES. Delikon Backshells are available in aluminum, stainless steel, brass, and steel, and come in various finishes. Different designs (i.e. straight, 45, and 90 degrees) are available and customization is always an option.



Delikon EMI Shielding Heavy Series Over Braided Flexible Conduit System

Delikon EMI Shielding Heavy Series Over Braided Flexible Conduit with Military Circular Connector Backshells, Adapters and Transitions Fittings

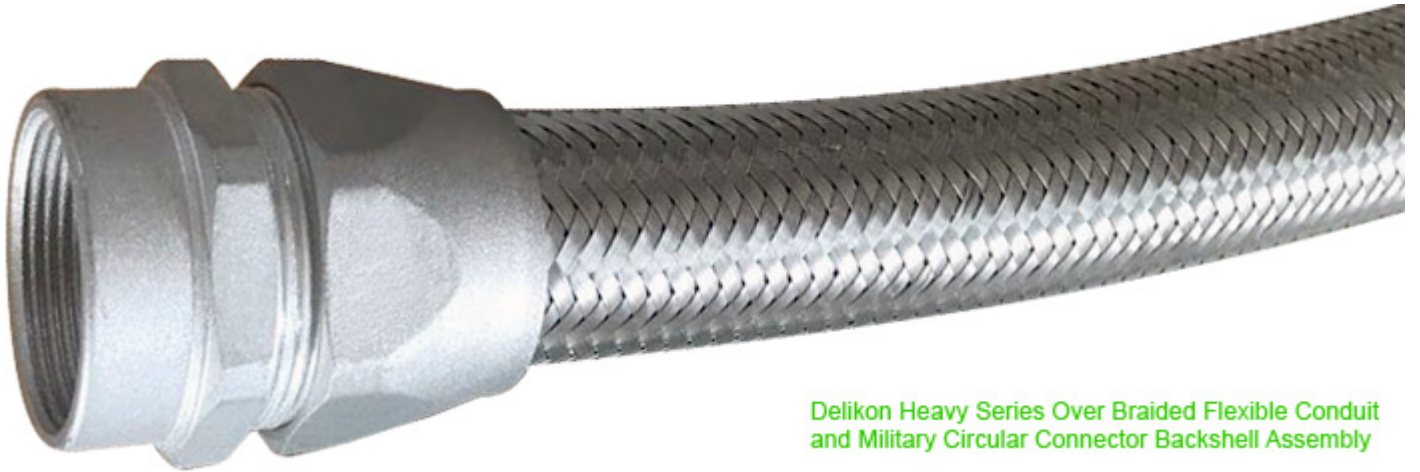

Delikon Heavy Series Over Braided Flexible Conduit and Military Circular Connector Backshell Assembly

Delikon Cable Protection Flexible Conduit with Conduit Adapter Backshell

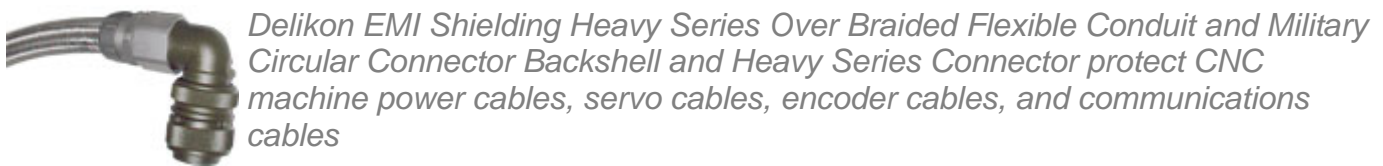

Delikon EMI Shielding Heavy Series Over Braided Flexible Conduit and Military Circular Connector Backshell and Heavy Series Connector protect CNC machine power cables, servo cables, encoder cables, and communications cables

Delikon Military Circular Connector Adapter is designed to connect a cylindrical connector to flexible conduit. Together with Delikon EMI Shielding Heavy Series Over Braided Flexible Conduit and Heavy Series Connector, this over braided flexible conduit assembly provides reliable protection to the cables connecting to Military Connector and is widely used for the automotive, robotics, machine tool and welding industries, as well as numerous other commercial applications from heavy equipment to ECG monitoring cables.